

SHARP

MX-4050N/MX-3550N/MX-3050N
Digital Full Colour Multifunctional System

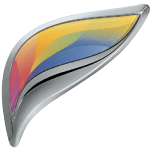

A3 COLOUR MFPs THAT
ARE ADAPTABLE TO YOUR
FUTURE NEEDS

When you invest in technology you're planning for growth
/This is Why our MFPs adapt to meet your needs.

There are always new challenges to overcome /This is Why our MFPs are fit for the future.

When it comes to office equipment, you're not just buying for today, you're investing in the future – preparing to meet new (perhaps unexpected) challenges. That's why, with their broad range of options and upgrades, our versatile A3 colour MFPs are a great choice now and in the years ahead.

There are three cloud-capable models to choose from: the high performance MX-4050N, which prints and copies at an impressive 40 pages per minute (ppm), our mid-range 35 ppm MX-3550N or, the 30 ppm MX-3050N for smaller workgroups.



ESSENTIAL FEATURES AND EXTRA VALUE OPTIONS

All the essentials as standard...

Every essential feature is included as standard and everything can be controlled from a large 10.1" colour LCD touchscreen, which tilts for easy viewing and gives you intuitive access to every function. It will even recommend the most environmentally-friendly setting for each task.

In addition, each user can customise the screen which supports multi-touch gestures for easily previewing and editing copy and scan jobs.

Scanning is fast and intuitive and you can scan mixed batches of colour and black & white documents automatically, even if they are of different sizes and weights.

Paper drawers accommodate up to SRA3 media and weights up to 300 g/m², for maximum versatility.

...with all these extra-value options to choose from

These new MFPs really are designed to adapt to your needs.

Options include:

- A wide range of finishing solutions including saddle-stitching, manual and stapleless stapling
- Single Sign-On capability for rapid access to popular cloud services
- Sharp OSA (Open Systems Architecture) for integration with network and cloud-based applications
- A range of Optimised Software Solutions for easier and more productive scanning, printing and mobile connectivity
- Compact PDF capability for scanning into convenient file sizes
- Adobe® PostScript® 3™ for enhanced graphics processing
- Fax expansion
- Job Separator Tray to prevent copy, print and fax jobs from getting mixed up

High quality. High productivity.

Time is often limited /This is Why our MFPs are designed to do so much more.

These versatile MFPs can act as print servers to give you 'Pull Printing' capability. This means that you can send a print job to your chosen device or use 'Print Release' to print your documents from another networked MFP, at a time and location that's convenient to you.

Not only does that give you the flexibility of collecting your output when you want but it also protects against sensitive documents being left out in the open.

COLLECT JOBS AT ANY NETWORKED MFP

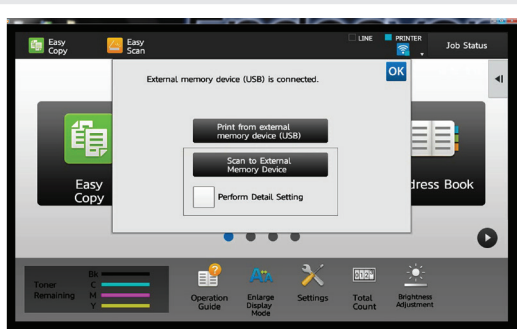

If you have Microsoft Office files on a USB memory stick you can simply plug into the MFP, select your files and start printing*. Scanning to the memory stick, or to the cloud or for immediate output, is just as easy.

SIMPLY PLUG YOUR USB MEMORY STICK INTO THE MFP AND START PRINTING

Our unique auto process control and developer refresh system work together to deliver page after page of consistently superior quality, and the Auto Colour Mode lets you scan and copy colour documents without the need to fine-tune any settings.

There's nothing complex, just consistently high quality from mixed content originals.

SUPERB IMAGE QUALITY



*Optional MX-PU10 required to print Microsoft Office files.

No one wants to read the manual /This is Why our MFPs make office life easier, for everyone.

It's important to invest in technology that's easy to use, with the minimum of intervention, so it's good to know that every major feature can be accessed from a highly customisable 10.1" colour LCD touchscreen. We've even added integrated web browsing.

There's nothing to learn and even the most advanced controls can be mastered in moments.

Advanced Functionality

We're all used to accessing data and documents from our phones, tablets and notebooks. But now you can print from them, too. Simply add the wireless LAN option and use Sharpdesk Mobile to print from your mobile device, using any App that supports Google Cloud Print™ or the Android™ printing framework.

We've added a Single Sign-On capability, too. That means that your team members can sign on at the control panel for immediate access to their favourite cloud applications and storage services, including Google Drive™, OneDrive® and SharePoint® Online, without having to re-enter their log in details. Printing directly from the cloud and scanning documents from the MFP up to the cloud has never been easier.

Tough security

Sharp MFPs come with robust security features, such as the encryption and secure erasure of data on the hard disk (automatically as well as on-demand), password controlled access for routine user authentication and a useful Data Initialisation feature to erase data from your MFP when the time comes to replace it.

For even greater security, a third party card reader adds tighter access control, and a secure network interface, SSL, IPsec and port-based network protection defend against the most determined attacks. We even help you prevent the unauthorised copying, scanning, faxing and filing of confidential documents, with our Document Control Function*.

We guard against accidents too, with features such as password-protected PDFs, a Hidden Pattern Print feature which can reveal a watermark and Confidential PIN Printing which requires the user to be present at the MFP before printing begins.

All this, plus S/MIME for secure email communications, advanced data protection and high security logins and user authentication.

Energy efficient

Low melt toner, configurable and automatic power on/off settings, Eco Scan and a shorter warm up time are just some of the many features that ensure extremely low energy consumption.

In addition, the control panel display will prompt users to select the most environmentally friendly option before starting a job and the toner cartridge automatically ejects only when the toner has been fully exhausted, eliminating waste.

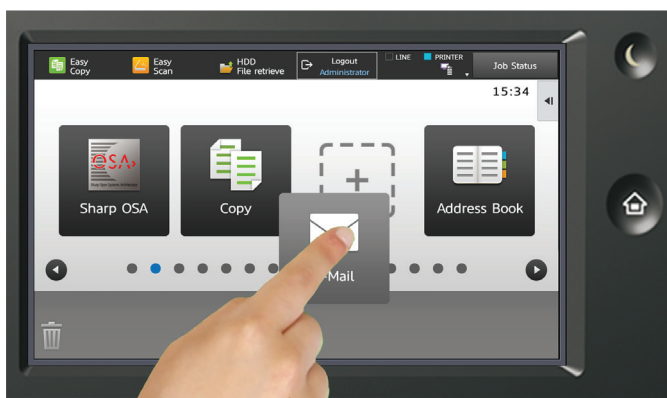

DRAG & DROP ICONS TO
CUSTOMISE THE HOME SCREEN

* Requires optional Data Security Kit.

Busy managers optimise productivity /This is Why Sharp optimises workflows.

The MX-4050N, MX-3550N and MX-3050N will transform the productivity of any workgroup. Your whole team will find that printing, copying, scanning and finishing documents is fast, easy and efficient. But that's just the start.

There's a full range of extra-value options and upgrades to choose from, too. For example, if you couple one of these next-generation MFPs with Cloud Portal Office and one or more of our Optimised Software Solutions, you'll see productivity elevated right across the workgroup.

Cloud Portal Office

Cloud Portal Office is our award-winning business-class collaboration service which connects phones, tablets, PCs, Sharp MFPs and our BIG PAD interactive whiteboards together in a single, seamless information environment.

In other words, everyone gets on-demand, walk-up access to every document that's stored in the cloud. You can also scan automatically indexed documents directly to a folder in the cloud, and send email alerts to colleagues who need them, all from the MFP.

Optimised Software Solutions

We've created our range of Optimised Software Solutions to help you reduce costs, increase efficiency and improve security. Do more with your new Sharp MFP and boost your productivity by adding one or more of these optional solutions:

Our **Optimised Printing Solutions** help you monitor and manage your print and copy usage, so you can eliminate unauthorised use, track and recover costs and reduce waste.

Our **Optimised Scanning Solutions** save time and prevent costly errors by simplifying and automating the capture, storage and sharing of documents, regardless of their format or purpose.

Our **Optimised Mobile Solutions** help people to connect tablets, phones and laptops simply and securely, so they're always in touch.

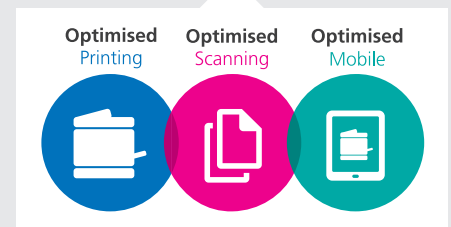

CLOUD READY MFP AND OPTIMISED SOFTWARE SOLUTIONS

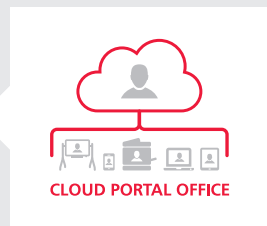

Configuration Examples

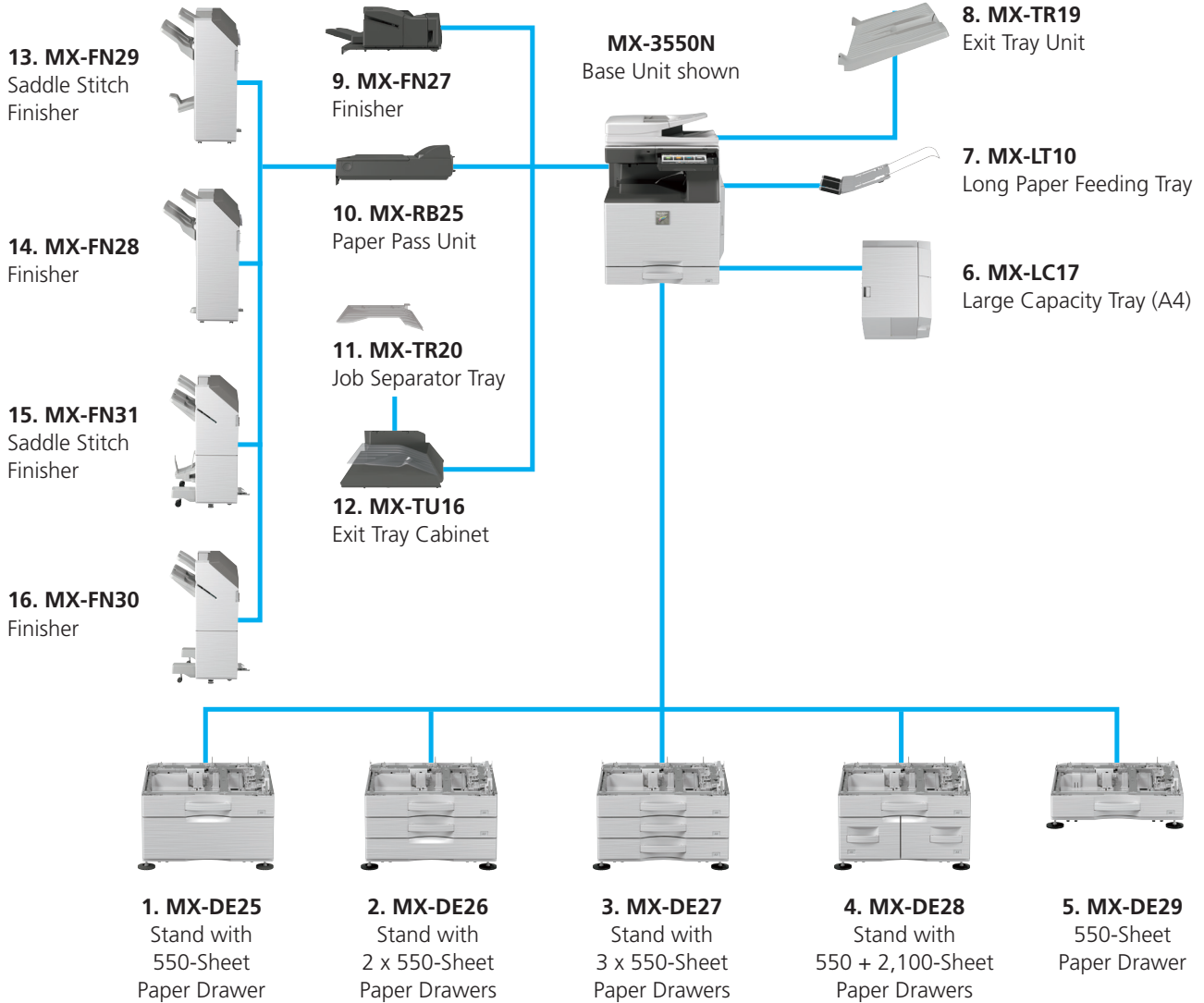

MX-3550N Base Unit
Exit Tray Cabinet
550-Sheet Paper Drawer



MX-3550N Base Unit
Inner Finisher
Stand with 550 + 2,100-Sheet Paper Drawers
Exit Tray Unit



MX-3550N Base Unit
Stand with 3 x 550-Sheet Paper Drawers
Finisher + Paper Pass Unit
Exit Tray Unit
Large Capacity Tray

Base Unit

1. MX-DE25 Stand with 550-Sheet Paper Drawer

550 sheets*¹, SRA3 to A5R (60 - 300 g/m²)

2. MX-DE26 Stand with 2 x 550-Sheet Paper Drawer

550 sheets*¹ each for lower and upper trays, SRA3 to A5R (60 - 300 g/m²)

3. MX-DE27 Stand with 3 x 550-Sheet Paper Drawer

550 sheets*¹ each for lower and upper trays, SRA3 to A5R (60 - 300 g/m²)

4. MX-DE28 Stand with 550 + 2,100-Sheet Paper Drawer

Upper tray: SRA3 – A5R, 550 sheets*¹ (80 g/m²)

Lower tray (Left): A4, 1,200 sheets*¹ (60 - 105 g/m²)

Lower tray (Right): A4 - B5, 900 sheets*¹ (60 - 105 g/m²)

5. MX-DE29*² 550-Sheet Paper Drawer

550 sheets*¹, SRA3 to A5R (60 - 300 g/m²)

6. MX-LC17*² Large Capacity Tray (A4)

3,000 sheets*¹, A4 - B5 (60 - 220 g/m²)

MX-UT10 Utility Table

Finishing

7. MX-LT10 Long Paper Feeding Tray

Recommended for banner printing

8. MX-TR19 Exit Tray Unit

9. MX-FN27 Inner Finisher

A3 - B5 (offset/staple), SRA3 - A5R (non offset)

Offset tray (upper): max. 500-sheet paper capacity*¹

Stapling capacity: max. 50-sheet multi-position staple*¹

Staple position: 3 locations (front, rear or 2 point stitching)

Manual Stapling: 1-point at rear (Flat), 45 sheets (64 g/m²),

40 sheets (80 g/m²)

Stapleless capacity: max.5-sheet (64 g/m²), 4 sheet (65 – 81.4 g/m²),

3 sheet (81.5 - 105 g/m²)

Stapleless position: 1-point at rear (Slant), A3 - B5

Optional Punch Module for MX-FN27:

MX-PN14C - 2/4 Hole Punch Module

MX-PN14D - 4 Hole Wide Punch Module

10. MX-RB25 Paper Pass Unit

Required when using MX-FN28, MX-FN29, MX-FN30 & MX-FN31

11. MX-TR20 Job Separator Tray

Requires MX-TU16 Exit Tray Cabinet

12. MX-TU16 Exit Tray Cabinet

13. MX-FN29 1k Saddle Stitch Finisher

A3W - A5R (offset/staple), SRA3 - A5R (non offset)

Offset tray (upper): max.1,000-sheet paper capacity*¹

Stapling capacity: max. 50-sheet multi-position staple*¹

Staple position: 1-point at front (Flat), 1-point at back (Flat),

2 point stitching

Saddle stitch tray (lower): 7 sets (11-15 sheets), 10 sets (6-10 sheets),

20 sets (1-5 sheets). 15 sheets max per set

14. MX-FN28 1k Finisher

A3W - A5R (offset/staple), SRA3 - A5R (non offset)

Offset tray (upper): max.1,000-sheet paper capacity*¹

Stapling capacity: max. 50-sheet multi-position staple*¹

Staple position: 1-point at front (Flat), 1-point at back (Flat),

2 point stitching

Optional Punch Module for MX-FN29 & MX-FN28:

MX-PN15C - 2/4 Hole Punch Module

MX-PN15D - 4 Hole Wide Punch Module

15. MX-FN31*² 3k Saddle Stitch Finisher

A3 - B5 (offset/staple), SRA3 - A5R (non offset)

Offset tray (upper): max.3,000-sheet paper capacity*¹

Stapling capacity: max. 65-sheet multi-position staple*¹

Staple position: 1-point at front (Slant), 1-point at back (Slant),

2 point stitching

Manual Stapling: 1-point at rear (Flat), 45 sheets (64 g/m²),

40 sheets (80 g/m²)

Stapleless capacity: max.5-sheet (64 g/m²), 4 sheet (65 – 81.4 g/m²),

3 sheet (81.5 - 105 g/m²)

Stapleless position: 1-point at rear (Slant), A3 - B5

Saddle stitch tray (lower): 10 sets (11-15 sheets),

15 sets (6-10 sheets), 25 sets (1-5 sheets). 20 sheets max per set

16. MX-FN30*² 3k Finisher

A3 - B5 (offset/staple), SRA3 - A5R (non offset)

Offset tray (upper): max.3,000-sheet paper capacity*¹

Stapling capacity: max. 65-sheet multi-position staple*¹

Staple position: 1-point at front (Slant), 1-point at back

(Slant), 2 point stitching

Manual Stapling: 1-point at rear (Flat), 45 sheets (64 g/m²),

40 sheets (80 g/m²)

Stapleless capacity: max.5-sheet (64 g/m²), 4 sheet (65 – 81.4 g/m²),

3 sheet (81.5 - 105 g/m²)

Stapleless position: 1-point at rear (Slant), A3 - B5

Optional Punch Module for MX-FN31 & MX-FN30:

MX-PN16C - 2/4 Hole Punch Module

MX-PN16D - 4 Hole Wide Punch Module

Printing

MX-PK13 PS3 Expansion Kit

Enables PostScript printing

MX-PU10 Direct Print Expansion Kit

MX-PF10 Barcode Font Kit

Enables barcode printing

Faxing

MX-FX15 Fax Expansion Kit

MX-FWX1 Internet Fax Expansion Kit

Connectivity

MX-EB18 Wireless LAN Adaptor

Enables connection to wireless networks

Scanning

MX-EB11 Enhanced Compression Kit

Enables creation of high compression PDFs

AR-SU1 Stamp Unit

Marks already scanned documents for checking

Sharpdesk Licenses

MX-USX1/X5

1/5-License Kit

MX-US10/50/A0

10/50/100-License Kit

Sharp OSA®

MX-AMX1 Application Integration Module

MX-AMX2 Application Communication Module

MX-AMX3 External Account Module

Security

MX-FR51U*² Data Security Kit

Commercial Version

*¹ Number of sheets based on 80 g/m². *² Available at a later date.

Specifications

General

| | | | |
|---|--|-----------|-------------|
| Engine speed (ppm/cpm) (Max) | A4* | A3 | SRA3 |
| MX-4050N | 40 | 20 | 18 |
| MX-3550N | 35 | 18 | 16 |
| MX-3050N | 30 | 16 | 15 |
| Control panel display | 10.1-inch colour LCD touchscreen | | |
| Paper size (Min – Max) | SRA3 – A5*2 | | |
| Paper weight (g/m ²) | Tray 60 - 300 Multi-bypass 55 - 300 | | |
| Paper capacity (Std – Max) | Sheets 650 - 6,300 Drawers 1 - 4 (plus bypass tray) | | |

| | |
|--------------------------------------|--|
| Warm-up time *3 (seconds) | 10 |
| Memory (GB) | Copier/Printer (shared) 5 HDD*4 250 |
| Power requirements | Rated local AC voltage $\pm 10\%$, 50/60 Hz |
| Power consumption (kW) (Max) | 1.84 (220 to 240V) |
| Dimensions (mm) (W x D x H)*5 | 608 x 650 x 834 |
| Weight (kg) | 79 |

Copier

| | | |
|-------------------------------------|--|------------|
| Original paper size (Max) | A3 | |
| First copy time *6 (seconds) | Full colour | B/W |
| | 6.7 | 4.7 |
| Continuous copies (Max) | 9,999 | |
| Resolution (dpi) | Scan (colour) 600 x 600 Scan (B/W) 600 x 600, 600 x 400, 600 x 300 Print 600 x 600, 9,600 (equivalent) x 600 (depending on copy mode) | |
| Gradation levels | 256 | |
| Zoom range (%) | 25 – 400, (25 – 200 using RSPF) in 1% increments | |
| Preset copy ratios (Metric) | 10 ratios (5R/5E) | |

Network Scanner

| | | |
|-------------------------------|--|------------------|
| Scan method | Push scan (via control panel) Pull scan (TWIN-compliant application) | |
| Scan speed *7 | One-sided | Two-sided |
| | 80 | 25 |
| Resolution (dpi) (Max) | Push scan 100, 150, 200, 300, 400, 600 Pull scan 75, 100, 150, 200, 300, 400, 600 50 to 9,600 dpi via user setting | |
| File formats | TIFF, PDF, PDF/A, encrypted PDF, compact PDF*8*9, JPEG*9, XPS | |
| Scan destinations | Scan to e-mail, desktop, FTP server, network folder (SMB), USB memory, HDD | |
| Scanner utilities | Sharpdesk | |

Wireless LAN (optional MX-EB18 required)

| | |
|-----------------------------|---|
| Compliant regulation | IEEE802.11n/g/b |
| Access mode | Infrastructure mode, Software AP mode |
| Security | WEP, WPA/WPA2-mixed PSK, WPA/WPA2-mixed EAP*10, WPA2 PSA, WPA2 EAP*10 |

Document Filing

| | | |
|-------------------------------------|--|--------------|
| Document filing capacity *11 | Pages | Files |
| Main & custom folders | 20,000 | 3,000 |
| Quick file folder | 10,000 | 1,000 |
| Stored jobs *12 | Copy, print, scan, fax transmission | |
| Storage folders | Quick file folder, main folder, custom folder (max. 1,000) | |

Network Printer

| | |
|---------------------------|---|
| Resolution (dpi) | 600 x 600, 9,600 (equivalent) x 600 |
| Interface | USB 2.0, 10Base-T/100Base-TX/1000Base-T |
| Supported OS | Windows Server® 2008, 2008R2, 2012, 2012R2, Windows Vista®, Windows® 7, 8.1, 10 Mac OS X 10.4, 10.5, 10.6, 10.7, 10.8, 10.9, 10.10, 10.11 |
| Network protocols | TCP/IP |
| Printing protocols | LPR, Raw TCP (port 9100), POP3 (e-mail printing), HTTP, FTP for downloading print files, IPP, SMB, WSD |
| PDL | Standard: PCL 6 emulation Adobe® PostScript®3™ |
| Available fonts | 80 fonts for PCL, 139 fonts for Adobe PostScript 3 |

Fax (optional MX-FX15 required)

| | |
|--|---|
| Compression method | MH/MR/MMR/JBIG |
| Communication protocol | Super G3/G3 |
| Transmission time *13 (seconds) | Less than 3 |
| Modem speed (bps) | 33,600 – 2,400 with automatic fallback |
| Transmission resolution (dpi) | 203.2 x 97.8 (Std) / 406.4 x 391 (Ultra Fine) |
| Recording width | A3 – A5 |
| Memory (GB) | 1 (built-in) |

External Dimensions

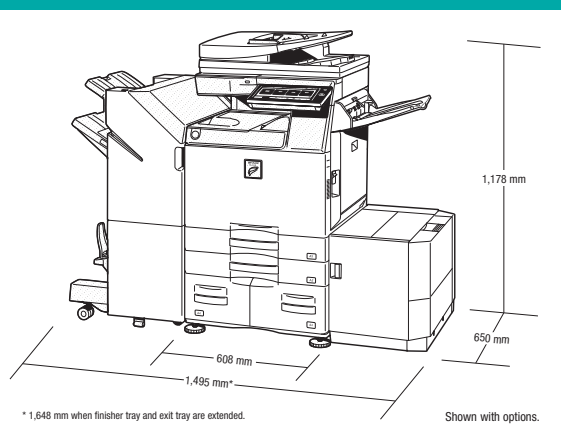

Notes

*1 Long-edge feeding. *2 Only short-edge feeding can be used with A5 paper. *3 At rated voltage, 23°C (73.4°F). May vary depending on operating conditions and environment. *4 HDD capacity depends on procurement and sourcing status. *5 Including adjusters and protruberances. *6 Long-edge feeding of A4 sheets from 1st paper tray, using document glass, without Auto Colour Selection and Auto Colour mode, MFP in fully ready condition. May vary depending on operating conditions and environment. *7 Based on Sharp's A4 standard chart, using document feeder and long-edge feeding. Using factory default settings with Auto Colour Selection off. Scan speed will vary depending on the type of document and the scan settings. *8 Requires optional MX-EB11. *9 Colour/greyscale only. *10 Not applicable to Software AP mode. *11 Storage capacity will vary depending on the type of document and the scan settings. *12 Some features require option(s). *13 Based on Sharp's standard chart with approx. 700 characters (A4 long-edge feeding) at standard resolution in Super G3 mode, 33,600 bps, JBIG compression.

Design and specifications are subject to change without prior notice. All information was correct at time of print. The ENERGY STAR logo is a certification mark and may only be used to certify specific products that have been determined to meet the ENERGY STAR programme requirements. ENERGY STAR is a US registered mark. Windows, Windows NT, Windows XP and Windows Vista are registered trademarks of Microsoft Corporation. Adobe and PostScript 3 are either registered trademarks or trademarks of Adobe Systems Incorporated in the U.S. and/or other countries. All other company names, product names and logotypes are trademarks or registered trademarks of their respective owners. ©Sharp Corporation February 2016. Ref: MX-4050N/MX-3550N/MX-3050N Brochure Job:17081. All trademarks acknowledged. E&OE.

SHARP

Inspiring ideas from technology

www.sharp.eu

